

**UNDERCOUNTER WASHBASIN
INSTALLATION INSTRUCTIONS**

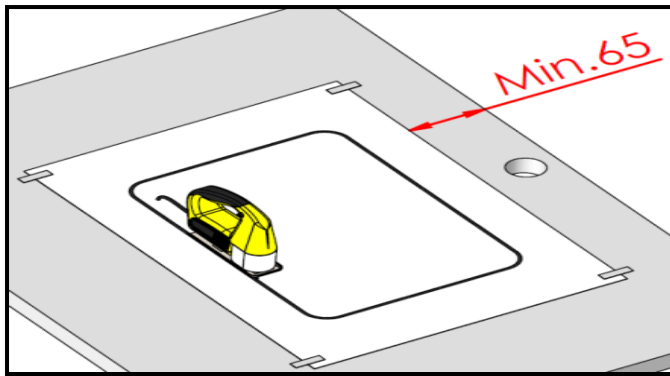

Attach the cutting template to the counter and cut the counter from the marked part.

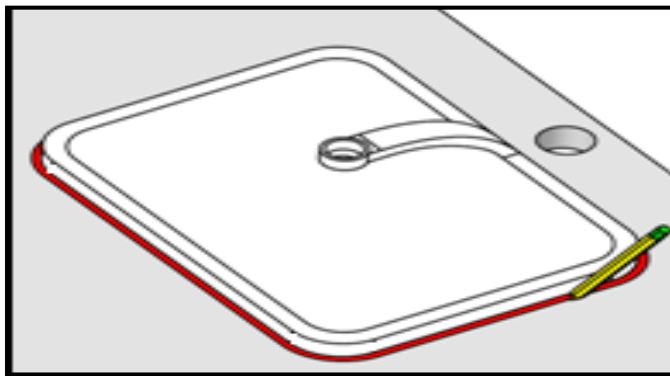

Place the washbasin under the counter temporarily and mark the edges.

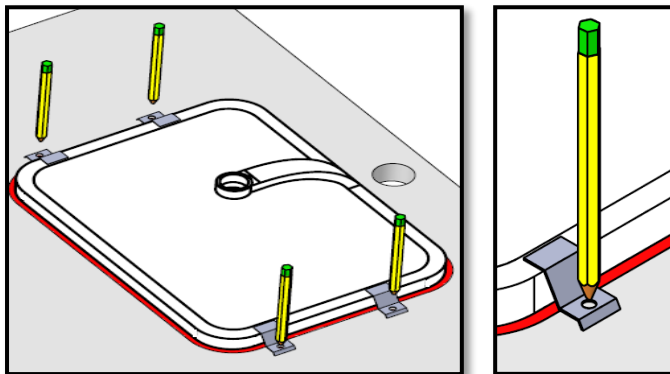

Place the installation apparatus and mark hole locations.

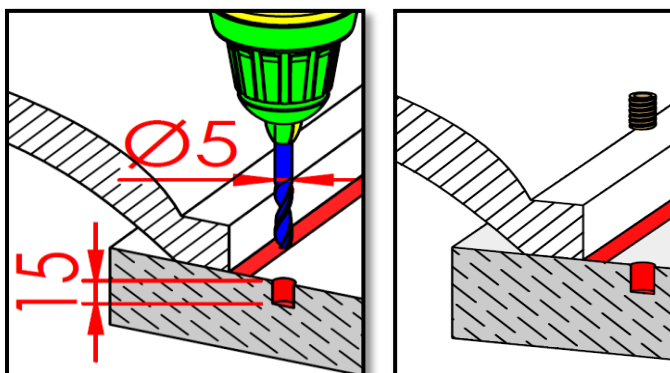

Open dowel holes and insert dowels. When using wooden countertops, fixing should be done with wood screws.

UNDERCOUNTER WASHBASIN INSTALLATION

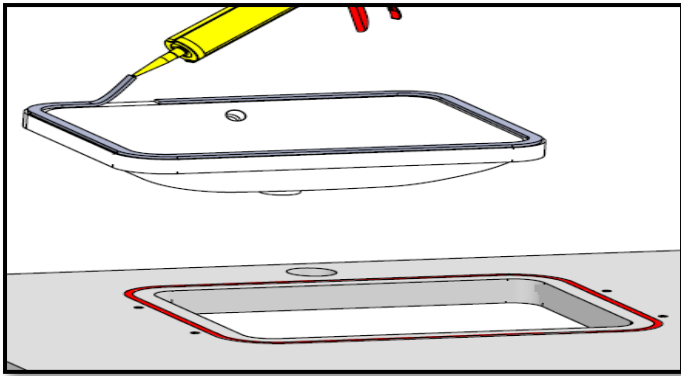

Apply silicone to washbasin installation surface.

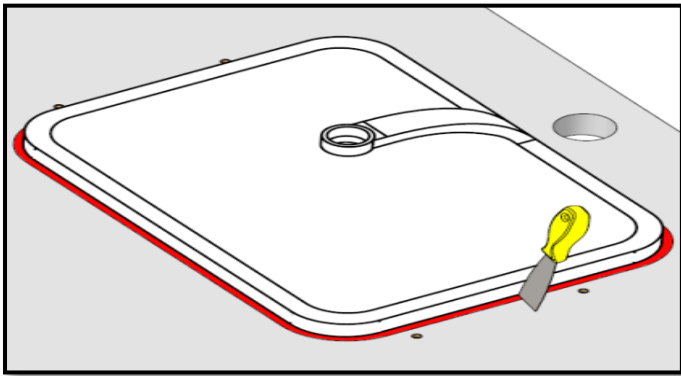

Place the washbasin and remove excessive silicone.

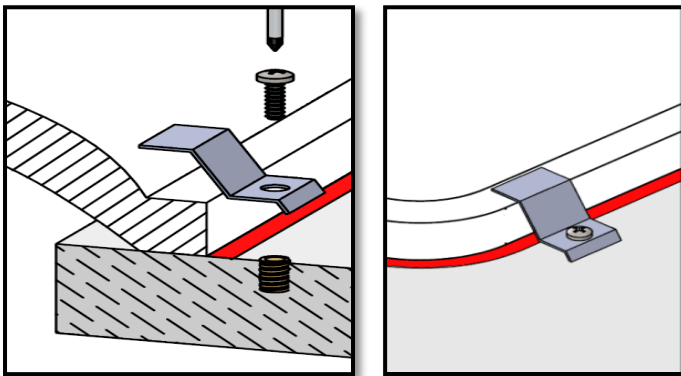

Fix the washbasin. When using wooden countertops, fixing should be done with wood screws.

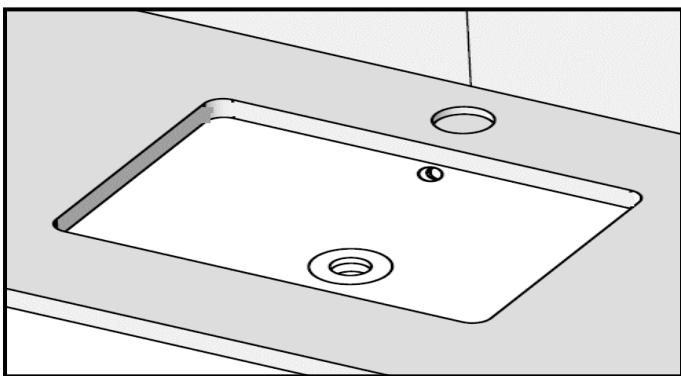

Complete the installation and wait for 24 hours.